

CC06

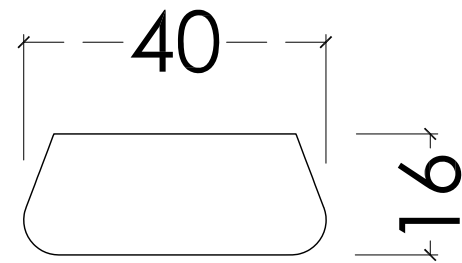

工程名稱 PROJECT	編號 JOB NO	比例 SCALE A3-S:1/20	設計 DESIGNED BY	說明 DESCRIPTION	圖號 DRAWING NO.	頁數 NUMBER
圖稱 TITLE	日期 DATE	單位 UNIT cm	校對 CHECKED BY	核准 APPROVED BY		版權所有 請尊重智慧財產權

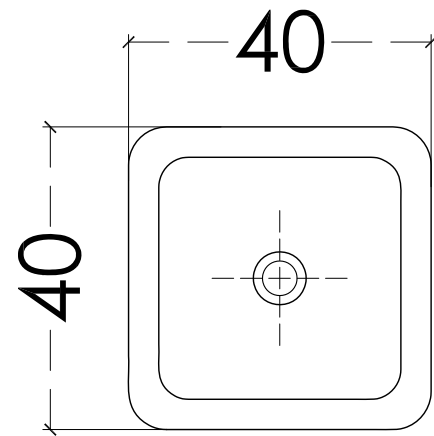